

Type-C Interface circuit

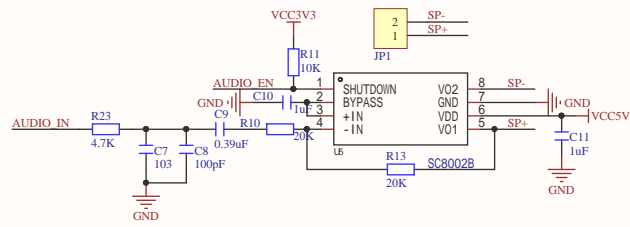

Audio power amplifier circuit

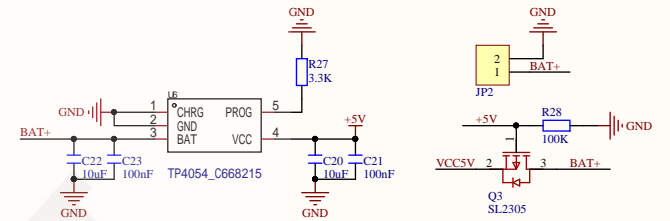

Battery charge and discharge management circuit

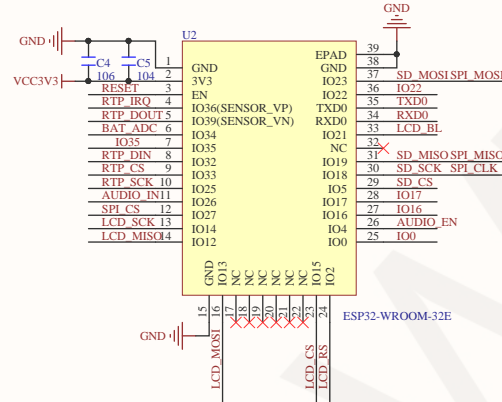

ESP32-WROOM-32E Main control circuit

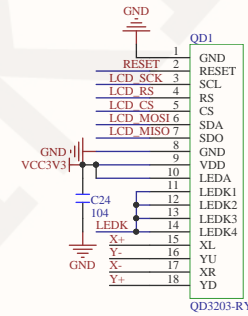

18P LCD panel wire welding interface

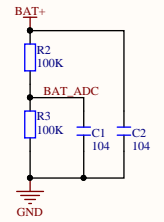

Battery level detection circuit

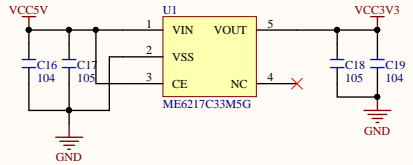

5V to 3.3V voltage regulator circuit

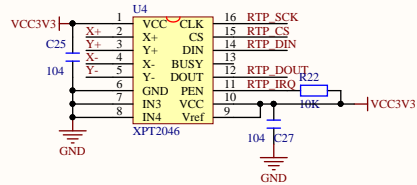

Resistive touch screen control circuit

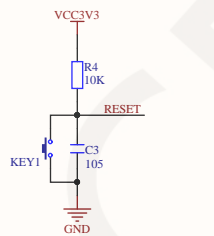

Key reset circuit

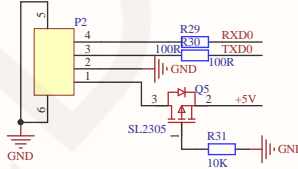

Serial port module interface circuit

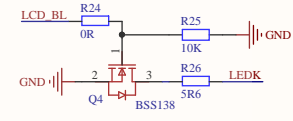

LCD screen backlight control circuit
High level lighting backlight

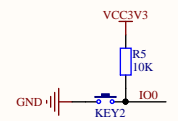

Download key circuit

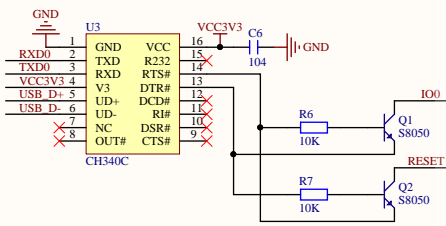

USB to serial port and one-click download circuit

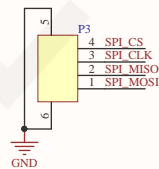

Expanded IO and peripheral interface circuits

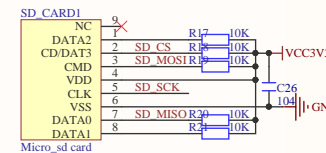
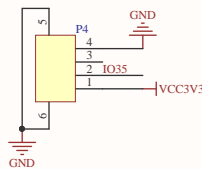

MicroSD card slot interface circuit

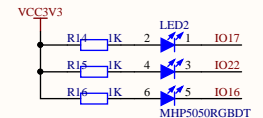

RGB three-color light control circuit
Common anode, low level lit LED light