

Type-C接口电路

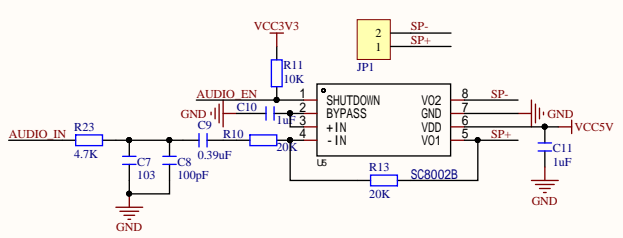

音频功放电路

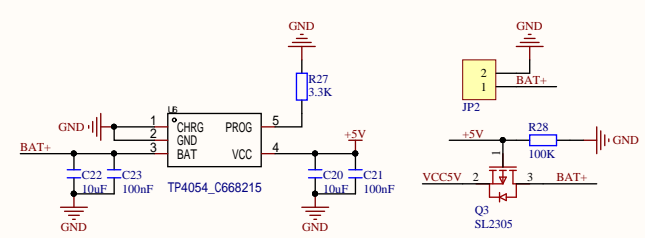

电池充放电管理电路

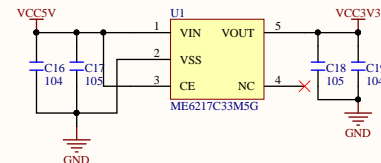

5V转3.3V稳压电路

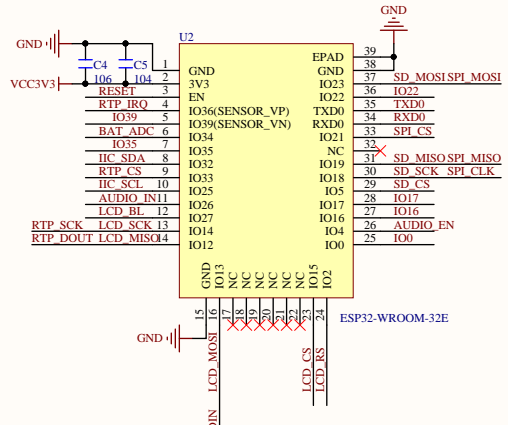

ESP32-WROOM-32E主控电路

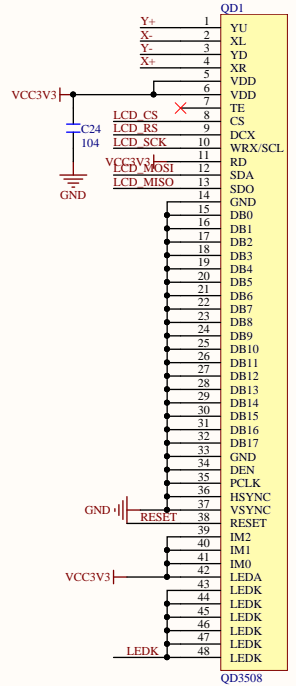

48P液晶屏排线焊接接口

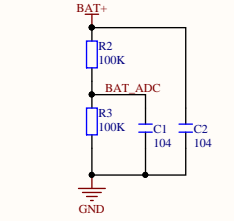

电池电量检测电路

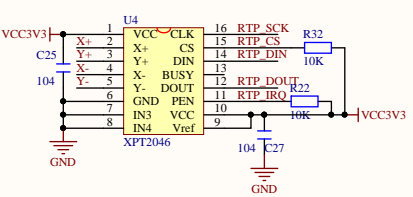

电阻触摸屏控制电路

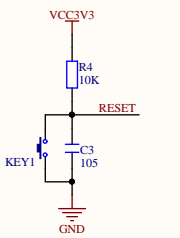

按键复位电路

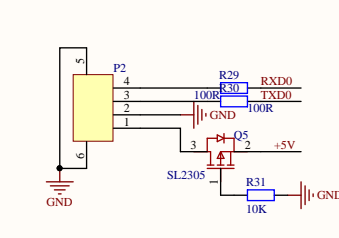

串口模块接口电路

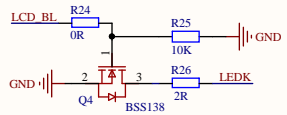

液晶屏背光控制电路  
高电平点亮背光

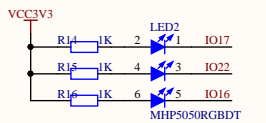

RGB三色灯控制电路  
低电平点亮LED灯

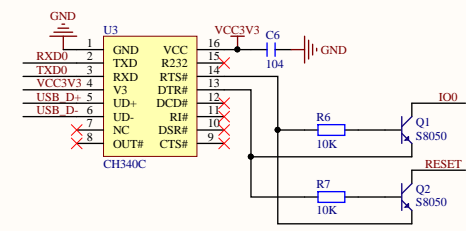

USB转串口以及一键下载电路

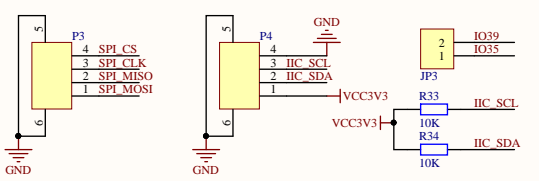

扩展IO以及外设接口电路

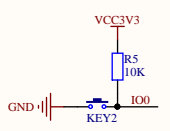

下载按键电路

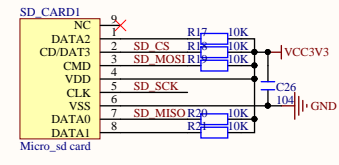

MicroSD卡槽接口电路